

BELIEVE 3666F

64 7/8" x 35" x 24"



PRODUCT DESCRIPTION:

Adjustable feet
 Transitional style
 Gloss finish resistant to stains and discoloration
 Acrylic thermoformed and reinforced with fiberglass

5 days

WATER CAPACITY: 78 gallons	IMMERSION: 17 1/2 po
BOX SIZE: 68" X 37" X 25"	
NET WEIGHT: 125 lbs	GROSS WEIGHT: 143 lbs

GENERAL OPTIONS

Acrylic Colors: White	Standard
Nuance*: (Allow 3 weeks delivery)	
Chromotherapy 1 light (Specify trim color)	17.99999.0000.00
Chromotherapy 2 lights (Specify trim color)	17.99999.0001.00
Chromotherapy 4 lights (Specify trim color)	17.99999.0002.00
Handle (1) (centered overflow's opposite side)	95.7077.106.XX
D105 Waste (20") Chrome	62.4020.102.60
Drain Adapter D-111-ABS 62.6010.100.00 or D-111-PVC 62.6010.101.00	
Gel black neck pillow (12"x 4 1/4 x 1 1/4")	18.6000.100.20
Rayola** (Specify control color)	

MASS-AIR/ACTIV-AIR OPTIONS

Mass-Air Jet finish: White/Chrome	Standard
Others: Chrome/Chrome	
Activ-Air Jet finish: Chrome, White	Standard
Blower Hose extension 96"	95.5013.168.00
144" Extension cord	95.3012.101.00

* Blower(s) must be installed in a remote location, extensions(s) provided.

*Customized products, non cancellable, non returnable.

**Not available with a neck pillow.

Possibility to install the FEN 990240 and TARON 990340 faucets

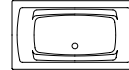

Bathtub only

BE3666F

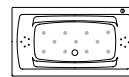

Mass-Air

BE3666FM*

Included: 21 (11-10) injectors, Optima blower 750W (1 1/2 h.p.) with 300W heating element, 6' blower hose extension and backlit electronic control.

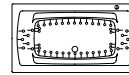

Activ-Air

BE3666FA*

Included: 48 micro-jets, Optima blower 750W (1 1/2 h.p.) with 300W heating element, 6' blower hose extension and backlit electronic control.

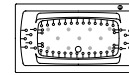

Mass-Air/Activ-Air Combo

BE3666FCMA*

Included: 48 Activ-Air micro-jets, 11 Mass-Air injectors, two Optima blowers 750W (1 1/2 h.p.) with 300W heating element, two 6' blower hose extension and backlit electronic control.



COMPLIANCE ATTESTATION
 Standard bathtubs
 CAN / CSA.B45.5
 Hydromassage Standards
 CAN / CSA.B45.10 / CSA.C22.2 / UL-1795



Certification ECORESPONSIBLE
 First manufacturer of bathroom products in North America to be certified ecoresponsible.



Produits Neptune
 6835, Picard street, Saint-Hyacinthe (Quebec) J2S 1H3
 Phone: (450) 773-7058 - Fax: (450) 773-5063
 produitsneptune.com



Produits Neptune

BELIEVE 3666 F

Bathtub

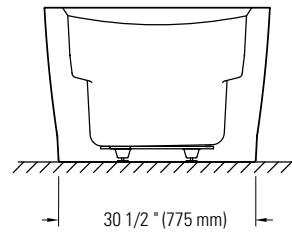
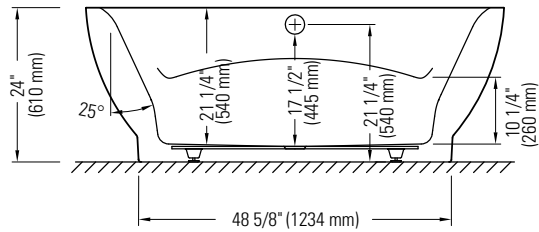
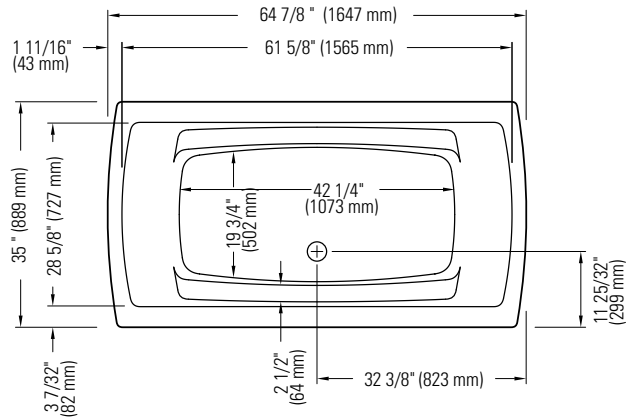

Left view

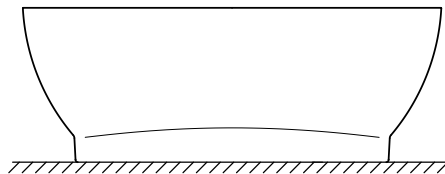

*All dimensions are approximate and subject to change without notice.
Please refer to the installation guide before beginning the installation